

THE HISTORY OF SUPERINSULATED HOUSES IN NORTH AMERICA

Martin Holladay

Senior editor, GreenBuildingAdvisor.com

British Columbia Building Envelope Council
Vancouver, British Columbia
September 22, 2010

CREDIT WHERE CREDIT IS DUE

- ✘ Thanks to those who answered my questions:
- ✘ Steve Bliss, Oliver Drerup,
Robert Dumont, Gautam Dutt,
Wolfgang Feist, David Hanson,
Gene Leger, J. Ned Nisson,
Harold Orr, William Rose

A CHRONOLOGICAL ACCOUNT

- ✘ This presentation will be a chronological account of important developments in superinsulation techniques from 1972 to 1986.
- ✘ It will also include details of my personal journey through those years.

SUPERINSULATION TIMELINE: 1974-1986

- 
- ← 1974: Princeton Center for Energy and Enviro. Studies
 - ← 1975: Lyngby House, Denmark
 - ← 1976: Lo-Cal House
 - ← 1977: The Saskatchewan Conservation House
 - ← 1977: Discovery of the Thermal Bypass
 - ← 1978: Gene Leger House
 - ← 1979: David Robinson House
 - ← 1980: The R-2000 Program
 - ← 1980: Commercial blower doors are sold
 - ← 1982: *Energy Design Update*
 - ← 1982: Chainsaw retrofit house
 - ← 1983: Low-e glazing
 - ← 1984: Commercial HRVs are sold
 - ← 1985: *Superinsulated House Book*
 - ← 1986: Montana Superinsulation Project

FIVE SUPERINSULATION MILESTONES

1. The 1970s energy crises led engineers to recalculate optimum insulation R-values.
2. Researchers discovered the importance of airtight construction and developed the blower door.
3. Builders developed ways to build high-R walls, to reduce thermal bridging, and to limit air leakage.
4. Researchers monitored the performance of model superinsulated homes, verifying what worked.
5. Manufacturers developed and began selling blower doors, HRVs, and low-e glazing.

THESE MILESTONES WERE MET BY 1985

- ✘ By 1985, North American builders interested in superinsulation had access to enough research data, had developed the techniques, and were able to purchase the required building materials necessary for building high-performance homes.

WE STILL HAVEN'T IMPLEMENTED THE BASICS

- ✘ Although all of these superinsulation milestones had been attained by 1985, these breakthroughs were not widely implemented.
- ✘ During the 1990s, the accomplishments of the superinsulation pioneers were largely forgotten.
- ✘ Even today, North American builders have failed to implement simple 30-year-old cost-effective strategies to reduce home energy use.

WHY ?

- ✘ Why were these accomplishments ignored — especially in the U.S. — and forgotten?
- ✘ Mainly because of *who* these superinsulation pioneers were ...

IGNORED AND FORGOTTEN

- ✘ They were hippies and Canadians.



1972: THE LIMITS TO GROWTH

- ✘ In 1972, the Club of Rome published an influential report, *The Limits to Growth*.

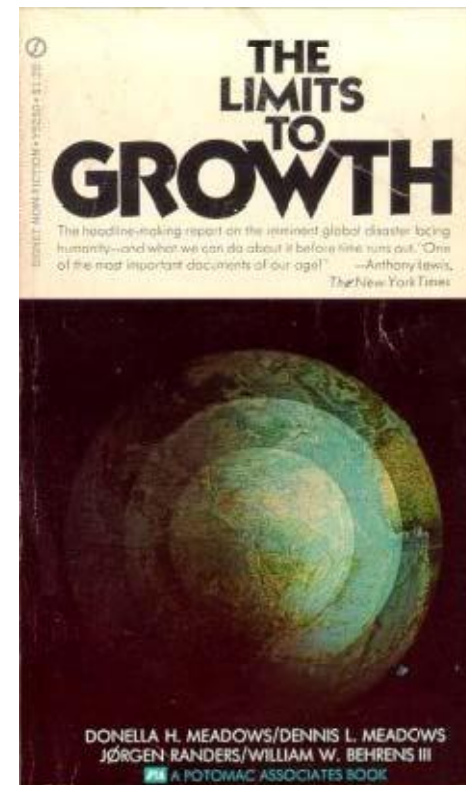

1972: THE LIMITS TO GROWTH

- ✘ The book predicted that future economic growth would be limited by resource shortages.
- ✘ *The Limits to Growth*: “Accepting the nature-imposed limits to growth requires no more effort than letting things take their course and waiting to see what will happen. The most probable result of that decision ... will be an uncontrollable decrease in population and capital. The real meaning of such a collapse is difficult to imagine.”

1973: I TAKE AN ENGINEERING COURSE

- ✘ As a Yale undergraduate in 1973, I took an engineering department course called “The Next Thirty Years.”
- ✘ The course analyzed the Club of Rome’s *Limits to Growth* report and weighed predictions of a looming energy crisis.



1973: I TAKE AN ENGINEERING COURSE

- ✘ Taught by Professor Arvid Herzenberg, the course investigated whether “natural resources may run short, and how technology and society could react” – topics now referred to by the shorthand phrases “global warming” and “peak everything.”
- ✘ In 2009, Professor Herzenberg said, “I think the Club of Rome had it absolutely dead right.”

1972: THE LIMITS TO GROWTH

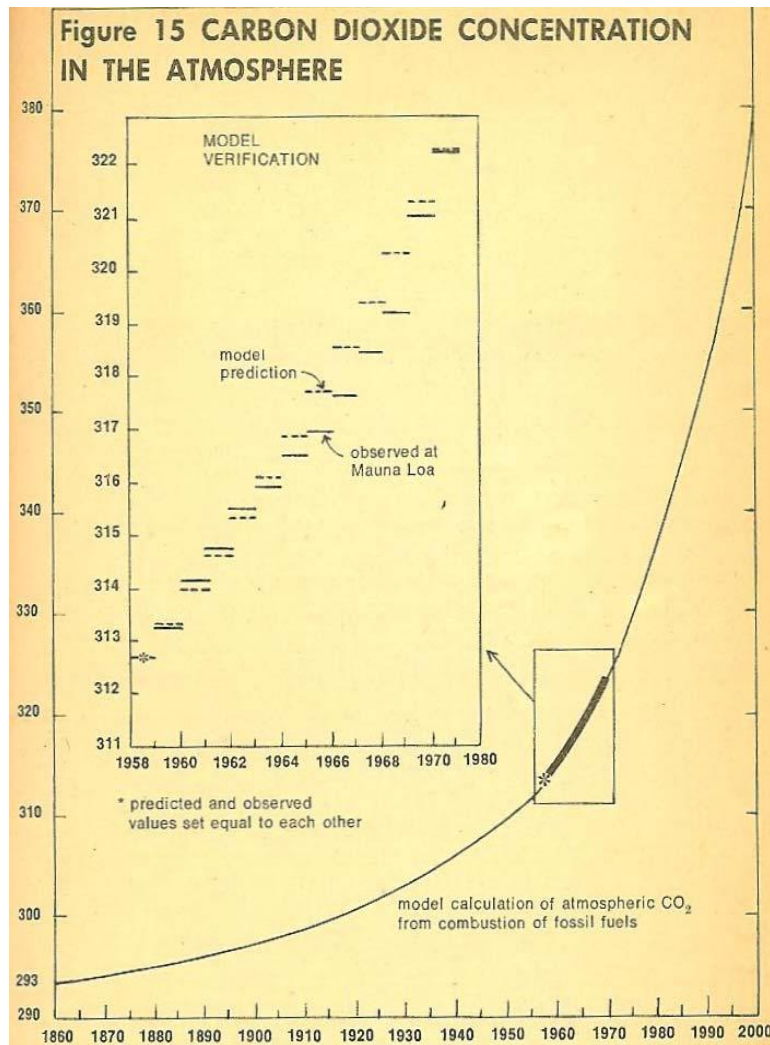

- In 1972, the CO₂ concentration in the atmosphere was 326 ppm.
- This graph predicted that by 2000, CO₂ would reach 380 ppm, a concentration that was actually reached in 2004.
- The current (2010) level is 392 ppm.

1973: THE OPEC OIL EMBARGO

- ✘ The OPEC oil embargo caused the price of oil to rise from \$3.56 a barrel in October 1973 to \$11.65 in January 1974.
- ✘ President Nixon declared that the U.S. will achieve energy independence by 1980.



1974: PRINCETON HOUSE DOCTORS

- ✘ In 1974, Princeton University's Center for Energy and Environmental Studies received a federal grant to study residential heat loss.
- ✘ At the Center, Ken Gadsby, Gautam Dutt, David Harrje, and Frank Sinden — a group later known as the “Princeton House Doctors” — performed research leading to an understanding of how air pressure dynamics affect heat loss in buildings.

1975: LYNGBY HOUSE, DENMARK

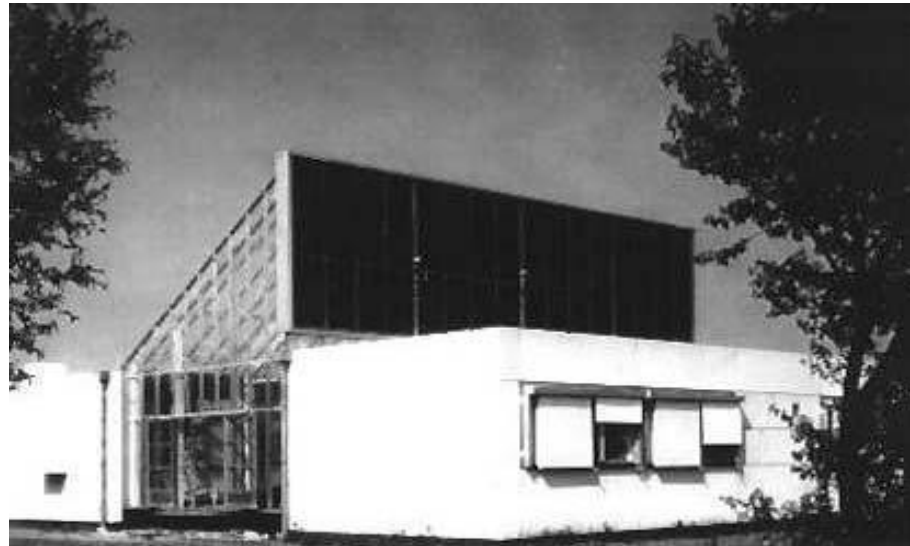

- ✘ In 1975, Vagn Korsgaard and T.V. Esbensen, researchers from the Technical University of Denmark, built a one-story demonstration house, the “Zero Energy House,” in Lyngby, Denmark.

1975: LYNGBY HOUSE, DENMARK

- ✘ According to Rob Dumont, this was “probably the first superinsulated house in the world.”
- ✘ Roof and wall insulation: 12 to 16 in. thick.
- ✘ Double-glazed windows with insulating shutters.
- ✘ Flat-plate solar thermal collectors connected to an 8,000-gal. storage tank.

1975: LYNGBY HOUSE, DENMARK

- ✘ Rob Dumont: “This amount of insulation was approximately 3 times as large as that used on most houses at the time. It incorporated ... one of the first air-to-air heat exchangers ever used on a domestic residence, and a solar heating system that was designed for 100% solar space and water heating.”

1976: WEATHERIZATION ASSISTANCE PROGRAM

- ✘ The U.S. Department of Energy's Weatherization Assistance Program was created by the Energy Conservation and Production Act of 1976.
- ✘ This national program was modeled on a small program in Maine, where community action agencies "sealed door, window, and other leaks in the building envelope."

1976: WEATHERIZATION ASSISTANCE PROGRAM

- ✘ Over the next 10 years, U.S. workers trained by the Weatherization program became a cohort of well-trained energy retrofit specialists who performed energy audits using infrared cameras and blower doors.
- ✘ These workers also became skilled at installing dense-packed cellulose insulation in existing walls.

1976: THE LO-CAL HOUSE

- ✘ In 1976, Wayne Schick at the University of Illinois at Urbana-Champaign developed a design for a superinsulated house that he called the “lo-cal house.”

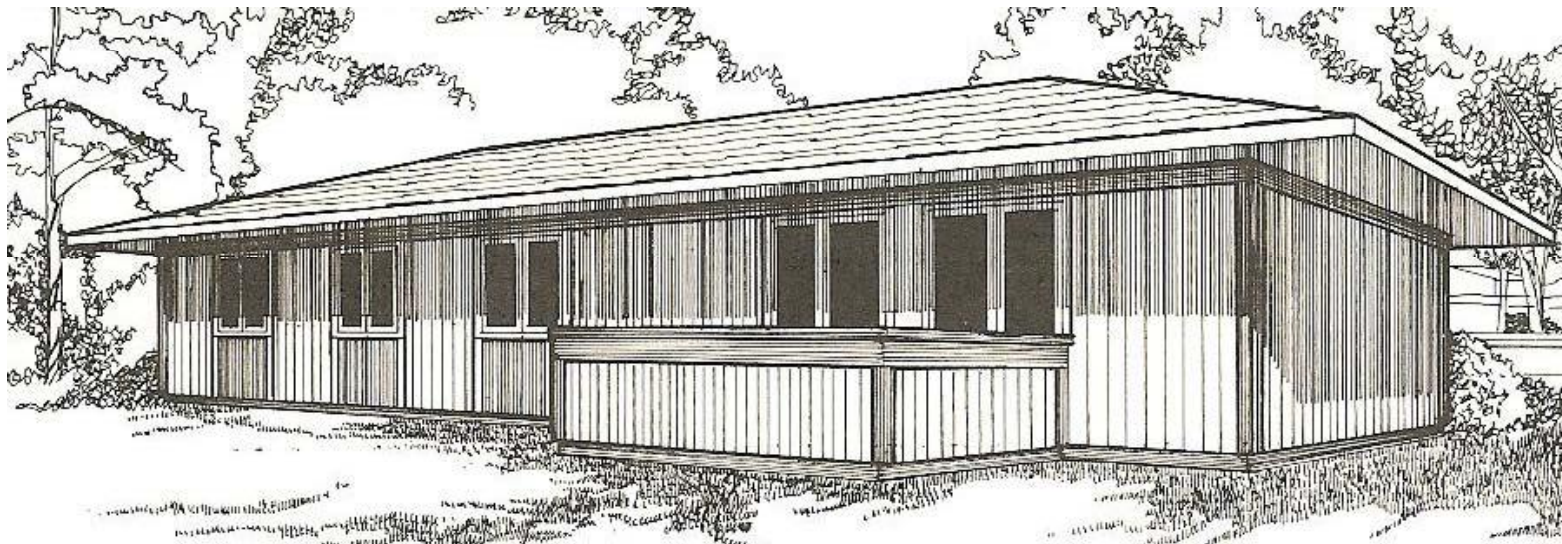

1976: THE LO-CAL HOUSE

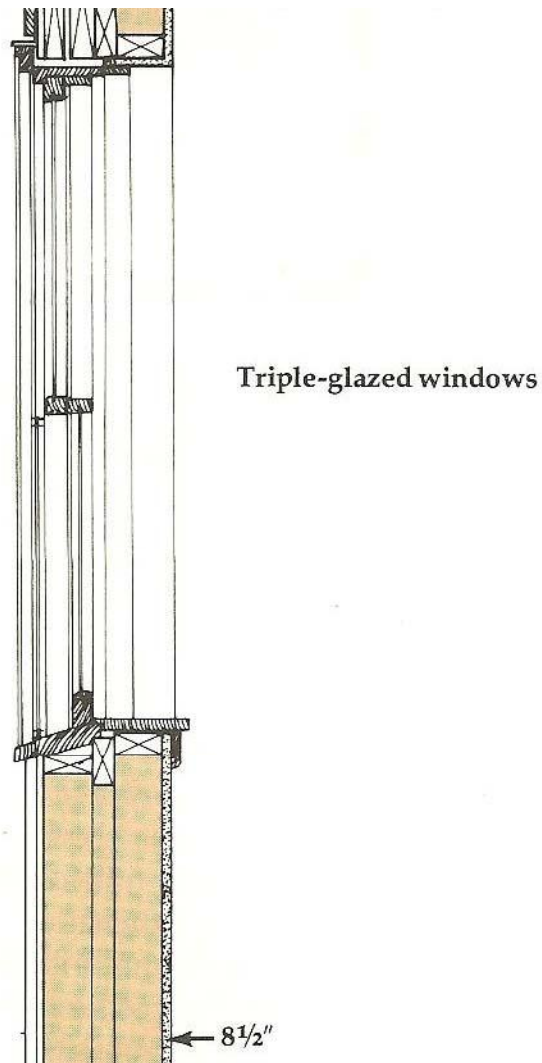

- ✘ Long axis of the house is oriented east-west.
- ✘ Double 2x4 walls (R-30)
- ✘ R-33 ceiling
- ✘ Triple-glazed windows
- ✘ An air-to-air heat exchanger

1976: THE LO-CAL HOUSE

- ✘ Wayne Schick: “From the standpoint of energy conservation, the initial design incorporated superinsulation for the shell of the house. It was anticipated that superinsulation would:
 - ✘ 1. Reduce the total energy demand of the house to a practical minimum,
 - ✘ 2. Reduce the requirement for solar gain from the south windows

1976: THE LO-CAL HOUSE

- ✘ 3. Enlarge the fraction of the total heat requirement provided by internal heat gains,
- ✘ 4. Reduce the requirement for heat storage in the internal mass of the house, and
- ✘ 5. Produce more comfortable interior surface temperatures, especially of the windows.”

[Wayne Shick, Rudard Jones, Warren Harris, Seichi Konzo, *Details and Engineering Analysis of the Illinois Lo-Cal House.*]

1977: SASKATCHEWAN CONSERVATION HOUSE



- R-40 walls
- R-60 ceiling
- Triple-glazed windows
- Heat-recovery ventilation
- Drainwater heat exchanger
- 0.8 ac/h @ 50 pascals

1977: SASKATCHEWAN CONSERVATION HOUSE

- ✘ Regina, Saskatchewan.
- ✘ Project engineers and designers included Robert Besant, Rob Dumont, David Eyre, and Harold Orr.
- ✘ Rob Dumont: “In a low-energy house, the internal heat gains from lights, appliances, pumps, etc. can supply a good fraction of the annual space heating requirement.”

1977: SASKATCHEWAN CONSERVATION HOUSE



In 1995, Rob Dumont summed up the “Overall lessons from the Saskatchewan Conservation House”:

- ✘ Simple is better than complicated
- ✘ Passive is better than active
- ✘ Moving parts fail

1977: DISCOVERY OF THE THERMAL BYPASS



- ✘ Princeton University researcher Gautam Dutt, studying heat loss at townhouses in Twin Rivers, N.J., discovered previously undocumented heat loss paths through and around attic insulation.
- ✘ Dutt is credited as the discoverer of the “thermal bypass.”

1977: DISCOVERY OF THE THERMAL BYPASS

✘ *New York Times*, July 22, 1979:

“Studies by Dr. Gautam S. Dutt ... suggest that fully 20 percent of the energy used to heat single-family, wood-frame houses is lost in warm air leaks to the attic. ... Of 30 or so houses he checked, all were losing three to seven times as much heat to the outside as the models predicted.”

1977: DISCOVERY OF THE THERMAL BYPASS

- ✘ According to Gautam Dutt, “The combination of the blower door and the infrared viewer — that was the innovation we developed at Princeton.”
- ✘ This innovation was soon adopted by dozens of weatherization crews and home energy auditors.

1977: HOMEMADE HRVS

- ✘ Early HRVs were homemade.
- ✘ “In the late 1970s, Canadian researchers at the University of Saskatchewan ... published construction plans that described how to make a rather large heat exchanger core from lengths of polyethylene plastic housed in a plywood box. About 5,000 sets of plans have been distributed, and many of these heat exchangers have been built.” [“Heat Recovery Ventilation for Housing,” 1984]

1977: HOMEMADE HRVS

- ✘ According to Oliver Drerup, “I was building airtight houses with our own heat recovery ventilation equipment by 1978.”

1977 OR 1979: GENE LEGER HOUSE



↑ 1979

2009 →



Most books cite 1979 as the date of Gene Leger's house in Pepperell, Massachusetts. However, Gene Leger says he built the house in 1977.

1977 OR 1979: GENE LEGER HOUSE

- ✘ No passive solar features
- ✘ Double 2x4 walls
- ✘ Very airtight construction
- ✘ Heated with a Paloma natural-gas on-demand water heater; annual heating bill: \$38.50.

1979: A DEBATE IS RESOLVED

- ✘ Gene Leger's house received widespread coverage in daily newspapers.
- ✘ Gene Leger's house tipped the balance in the raging debate between passive solar design and superinsulation: **The debate was resolved in favor of superinsulation.**

SUPERINSULATION VERSUS PASSIVE SOLAR

- ✘ The two sides of the “superinsulation vs. passive solar” debate were represented by different periodicals.
- ✘ On the superinsulation side was a monthly newsletter, *Energy Design Update*.
- ✘ On the passive solar side was a monthly magazine, *Solar Age*. The construction technology editor of *Solar Age* was Steve Bliss.

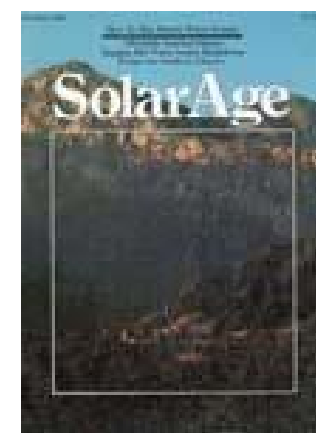

SUPERINSULATION VERSUS PASSIVE SOLAR

- ✘ Since I used to edit *EDU*, you can guess what I think. But what does Steve Bliss think?
- ✘ Steve Bliss: “For one of my first articles for *Solar Age*, I interviewed two college professors living in a solar house in the Boston suburbs. When I got there, they were sitting in the house freezing — they were wearing down booties and down vests. They were suing their architect, who had used solar glazing formulas developed for houses in the Southwest.”

SUPERINSULATION VERSUS PASSIVE SOLAR

- ✘ Steve Bliss: “These passive solar houses just didn’t work in New England. A lot of people were building solar houses that weren’t working. Companies started inventing things to fix these houses — solar shades, insulating shutters, rock bins. *Solar Age* analyzed all of these things, and we wrote that all of them failed. I wrote a lot of articles about what wasn’t working.”

SUPERINSULATION VERSUS PASSIVE SOLAR

- ✘ Steve Bliss: “There was a new perpetual motion machine every six months. Proprietary things, magic things. We used to call these houses ‘smart air houses’ — where the air would follow the blue arrows and the red arrows. The smart air knew where to go.”

SUPERINSULATION VERSUS PASSIVE SOLAR

- ✘ Steve Bliss: “What emerged over time was that the smart money was putting more effort on conservation. Passive solar is a weak heating system — so it’s really important to hang on to the heat you have. There was more and more interest in the building shell. Insulate really well and build a tight house. If you reduce the amount of glazing, you reduced a lot of your problems — overheating in the summer and excessive heat loss in the winter.”

SUPERINSULATION VERSUS PASSIVE SOLAR

- ✘ *Solar Age* magazine ceased publication in 1986.
- ✘ Steve Bliss: “At that time, interest in solar technology was dropping and interest in energy-efficient construction was growing.”

1978- SUIPERINSULATION WORKSHOPS



- ✘ In the late 1970s, Joel Ned Nisson, a Massachusetts engineer, was inspired by a report describing the Saskatchewan Conservation House.
- ✘ Nisson: “I invited Harold Orr and Rob Dumont to Massachusetts, and we started running workshops. The workshops were wildly popular.”
- ✘ Harold Orr: “We traveled to Boston, Chicago, New York City — a half dozen places — speaking to builders and architects and people interested in energy.”

1979: THE WHITE HOUSE GETS SOLAR THERMAL

- ✘ On June 20, 1979, Jimmy Carter inaugurated the newly installed solar hot water system on the White House roof.



1979: DAVID ROBINSON HOUSE, SOLAR AGE

- ✘ “The Art of the Possible in Home Insulation” by David A. Robinson appeared in the October 1979 issue of *Solar Age* magazine.

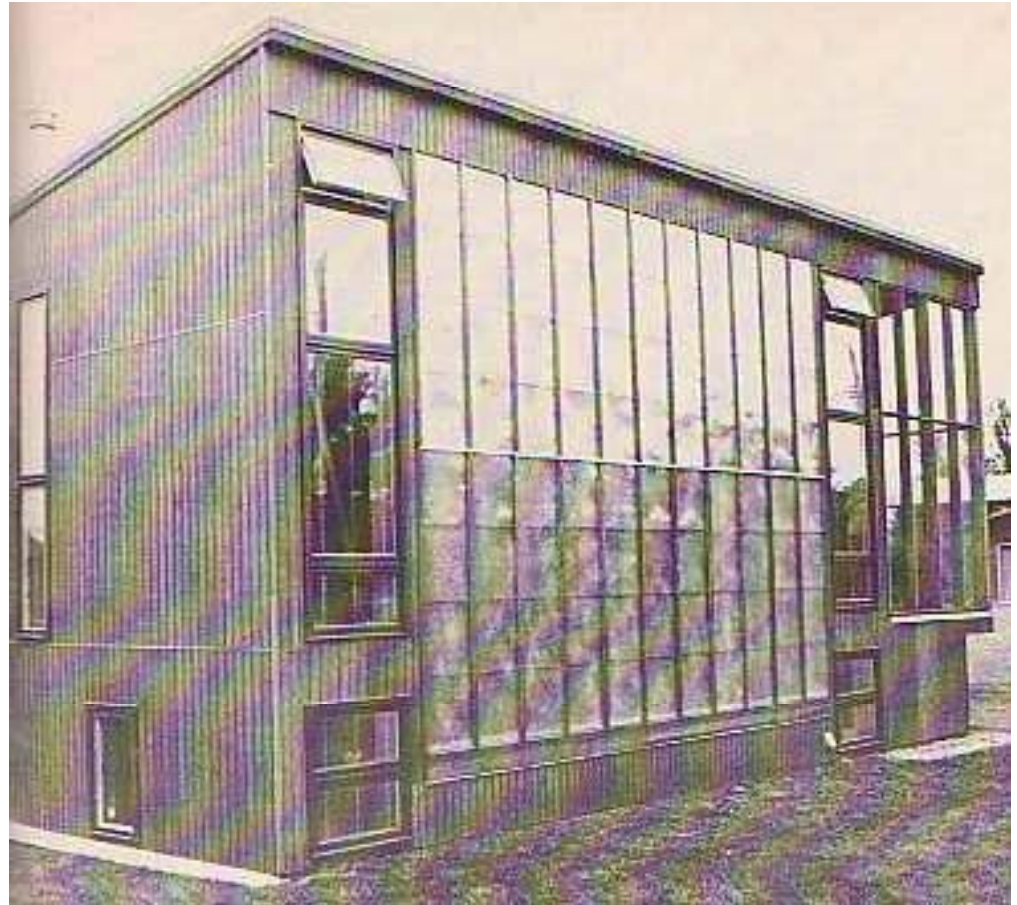

1979: DAVID ROBINSON HOUSE, SOLAR AGE

- ✘ Location: Northfield, Minnesota, U.S.A.
- ✘ Careful air sealing.
- ✘ Double-glazed windows on the south; triple-glazed elsewhere.
- ✘ R-30 walls (2x8 studs, 1-in. exterior EPS foam).
- ✘ R-60 roof insulation.
- ✘ Attention to thermal bridging: recessed rim joists made room for 1 in. exterior EPS foam.

1979: DAVID ROBINSON HOUSE, SOLAR AGE

- ✘ R-16 basement walls.
- ✘ R-16 under the basement slab.
- ✘ Half of the window area faces south.
- ✘ Active solar space heating system.
- ✘ Heat-recovery ventilator.

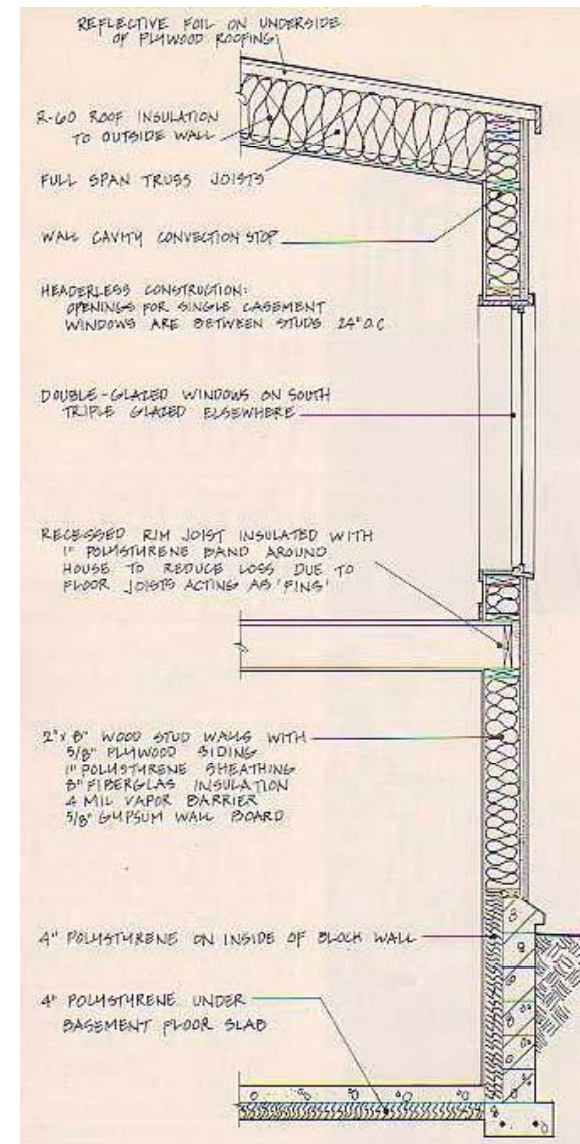

1979: DAVID ROBINSON HOUSE, SOLAR AGE

- ✘ “Life-cycle costs were considered at the earliest stage. The method quickly led to the conclusion that greatly increased insulation levels would save money in the long run.”
- ✘ “The main result of using these guidelines for the Minnesota house was the conclusion that all insulation values should be doubled compared with current practice for even inexpensive gas heat, if a 28-year life-cycle were chosen.”

1979: DAVID ROBINSON HOUSE, SOLAR AGE

- ✘ Air leakage testing: “Using an ethane gas tracer technique, the natural infiltration rate of the house was measured to be .12 air changes per hour in a 15-mph wind. This test was made with all the natural vents open (bathroom fan, clothes dryer, air-to-air heat exchanger).”

1979: THE SECOND OIL PRICE SHOCK

- ✘ The Iranian revolution caused world oil prices to rise from \$15 to \$37 a barrel.



I was in Tehran in 1979. Here I am with my Iranian friends.

1979: CARTER RESPONDS TO THE ENERGY CRISIS

- ✘ President Jimmy Carter pledged that the U.S. would attain energy independence by 1990.
- ✘ Carter declared in 1979, “Beginning this moment, this nation will never use more foreign oil than we did in 1977 – never.”



1979: WILLIAM SHURCLIFF'S PRESS RELEASE



- ✘ June 1979: A prescient document:
- ✘ “Consider the Saskatchewan Energy Conserving Demonstration House. Or consider the Leger House in Pepperell, Mass. They fit none of the ... listed categories [of solar houses]. The essence of the new category is:
 - ✘ 1. Truly superb insulation. Not just thick, but clever and thorough. Excellent insulation is provided even at the most difficult places: sills, headers, foundation walls, windows, electric outlet boxes, etc.

1979: WILLIAM SHURCLIFF'S PRESS RELEASE

- ✘ 2. Envelope of house is practically airtight. Even on the windiest days the rate of air change is very low.
- ✘ 3. No provision of extra-large thermal mass. (Down with Trombe walls! Down with water-filled drums and thick concrete floors!)
- ✘ 4. No provision of extra-large south windows. Use normal number and size of south windows — say 100 square feet.

SHURCLIFF'S 1979 PRESS RELEASE

- × 5. No conventional furnace. Merely steal a little heat, when and if needed, from the domestic hot water system. Or use a minuscule amount of electrical heating.
- × 6. No conventional distribution system for such auxiliary heat. Inject the heat at one spot and let it diffuse throughout the house.
- × 7. No weird shape of house, no weird architecture.

SHURCLIFF'S 1979 PRESS RELEASE

- ✘ 8. No big added expense. The costs of the extra insulation and extra care in construction are largely offset by the savings realized from not having huge areas of expensive Thermopane [windows], not having huge well-sealed insulating shutters for huge south windows, and not having a furnace or a big heat distribution system.
- ✘ 9. The passive solar heating is very modest — almost incidental.

SHURCLIFF'S 1979 PRESS RELEASE

- ✘ 10. Room humidity remains near 50 percent all winter. No need for humidifiers.
- ✘ 11. In summer the house stays cool automatically. There is no tendency for the south side to become too hot — because the south window area is small and the windows are shaded by eaves.

SHURCLIFF'S 1979 PRESS RELEASE

- ✘ What name should be given to this new system? Superinsulated passive? Super-save passive? Mini-need passive? Micro-load passive? ... Whatever it is called, it has (I predict) a big future.”

1982: THE R-2000 PROGRAM

- ✘ In 1980, a group of 10 superinsulated houses were built in Saskatoon, leading to the launch of the R-2000 program in 1982.



1982: THE R-2000 PROGRAM

- ✘ Rob Dumont: “The [R-2000] program had a strong emphasis on performance, as opposed to prescriptive standards for energy use for space heating. ... The first group of monitored R-2000 houses consumed about 57% less energy than conventional houses.”

1980: THE BLOWER DOOR

- ✘ In 1980, Ken Gadsby's company, Gadsco, began selling the first commercially available blower doors.
- ✘ The blower door was invented in the 1970s by several researchers working simultaneously and independently. These researchers included Harold Orr in Saskatoon and Ake Blomsterberg in Sweden.

THE BLOWER DOOR

- ✘ Harold Orr: “In the early 1970s, we started doing pressure testing. The people at Princeton were a totally separate group of people who were unaware of what we were doing. We were pressure testing houses using a 12-inch duct running out the basement window with a fan at the end of the duct. I decided to take a piece of plywood that would fit into a door. We rigged it so that it would work with either a 32-inch or a 36-inch door.”

THE BLOWER DOOR

- ✘ Harold Orr: “We were using a vane axial fan — a 28-volt DC fan used in the aircraft industry. I hooked the fan up to a variable-voltage power supply so we could run it at any speed we wanted. Then I put a venturi on the front of the fan. Gary Nelson picked up the idea, and ordered fiberglass venturis from our fiberglass manufacturer in Saskatoon.”

THE BLOWER DOOR

- ✘ Although Princeton University researchers are usually credited as the inventors of the portable blower door, Gautam Dutt agrees that the Canadians were doing similar, simultaneous work.
- ✘ “The Canadians were ahead of us in many ways,” said Dutt. “They had a company making house pressurization devices at about the same time as we developed the blower door, but it was less portable.”

THE BLOWER DOOR

- ✘ In 1981, Harry Sherman and his son Max Sherman started selling blower doors under the Harmax brand.
- ✘ A year later, Gary Nelson, the founder of The Energy Conservatory, started selling the Minneapolis blower door.
- ✘ Of the three pioneering companies — Gadsco, Harmax, and the Energy Conservatory — only the Energy Conservatory is still in business.

1981: THE SUPERINSULATED RETROFIT BOOK

- ✘ *The Superinsulated Retrofit Book* by Brian Marshall and Robert Argue was published in 1981.

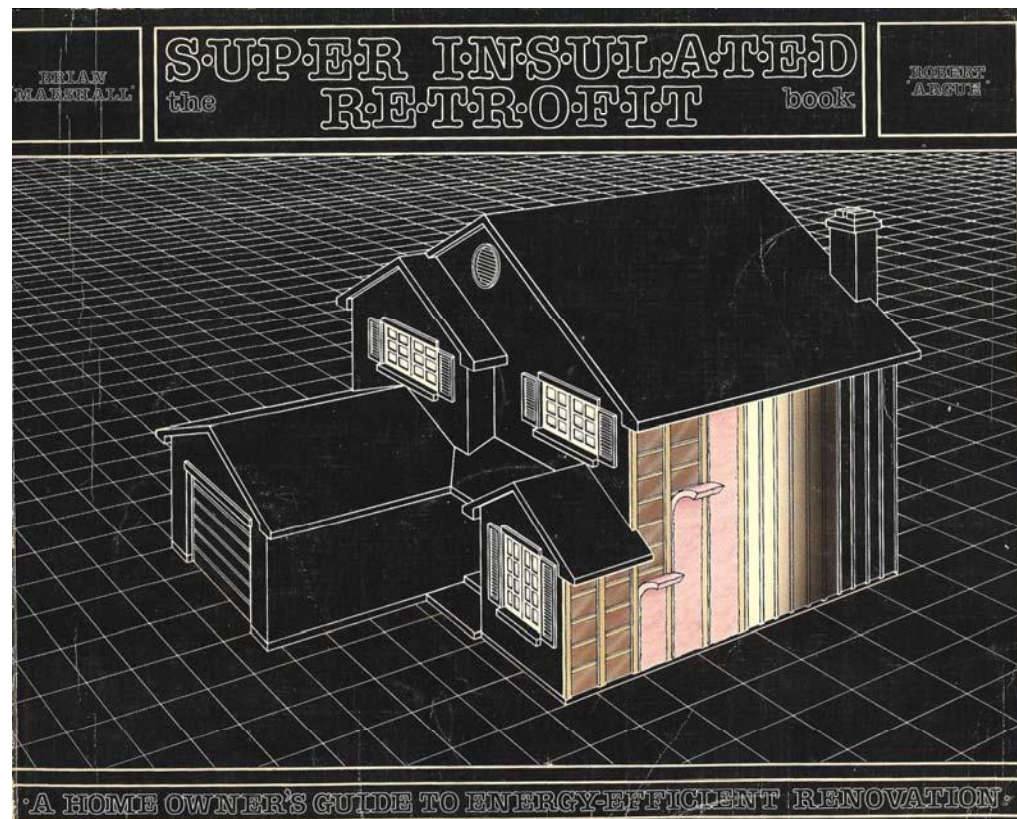

1981: THE SUPERINSULATED RETROFIT BOOK

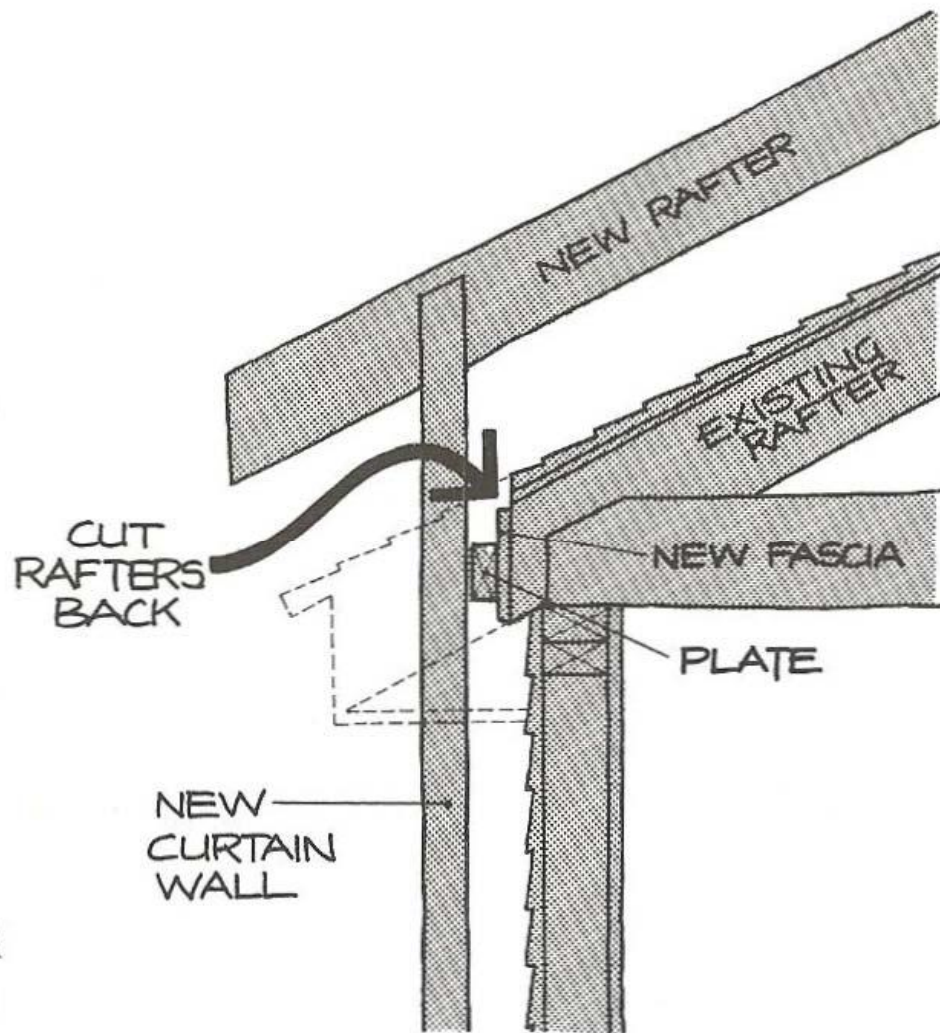

This Canadian book included the first published description of the “chainsaw retrofit” method.

1982: ENERGY DESIGN UPDATE

- ✘ J. Ned Nisson published the first issue of *Energy Design Update*, a superinsulation newsletter, in July 1982.

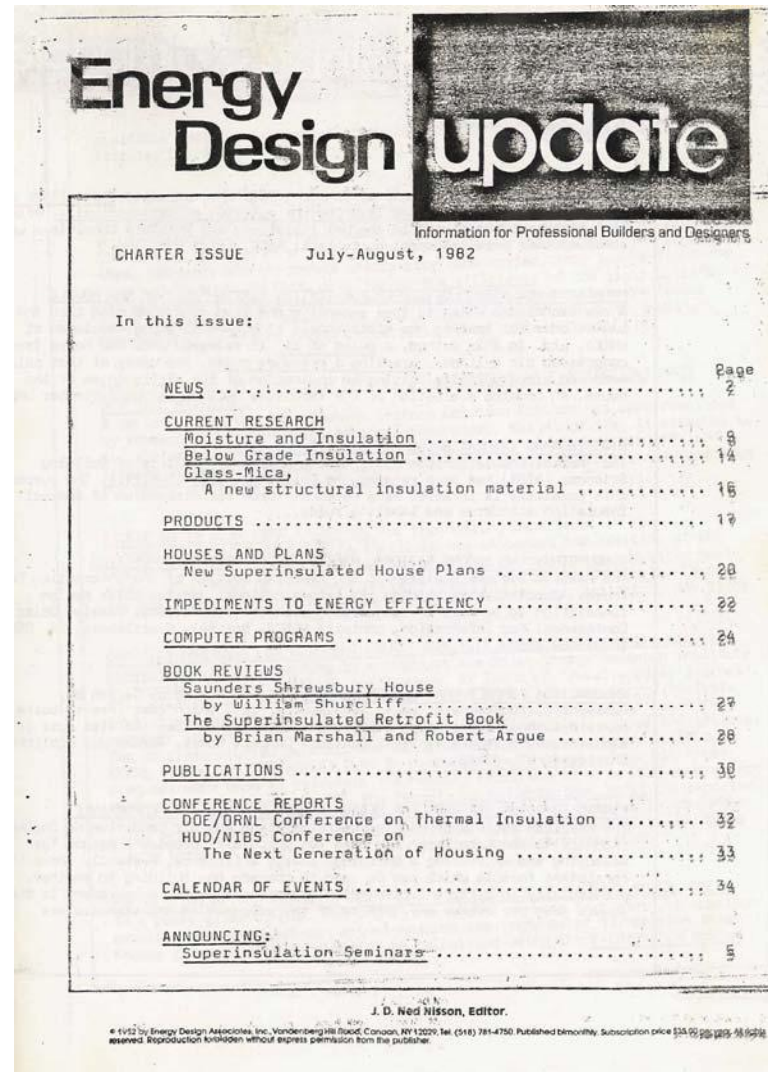

1982: CHAINSAW RETROFIT HOUSE



Researchers
Rob Dumont
and Harold Orr
performed a
deep-energy
retrofit at 31
Deborah
Crescent,
Saskatoon,
Saskatchewan,
Canada

1982: CHAINSAW RETROFIT HOUSE

- ✘ The roofing and siding were stripped.
- ✘ A tight exterior air barrier was installed over the wall and roof sheathing.
- ✘ R-43 insulation was installed on the exterior of the walls and roofs.
- ✘ The existing double-glazed windows received a third layer of glazing.
- ✘ New siding and roofing was installed.
- ✘ An HRV was installed.

1983: LOW-E GLAZING

- ✘ Cardinal low-e glazing became an available option for most Andersen windows in 1983.
- ✘ Although Andersen was the first to market low-e glass, several other residential window manufacturers, including Marvin, offered low-e glazing by 1984.
- ✘ “By the mid-1980s, virtually every major manufacturer was offering low-E windows.”

[Evan Mills, Lawrence Berkeley National Laboratory

1984: HEAT-RECOVERY VENTILATORS

- ✘ In February 1984, the National Center for Appropriate Technology in Butte, Montana prepared a report, “Heat Recovery Ventilation for Housing,” for the U.S. Dept. of Energy.

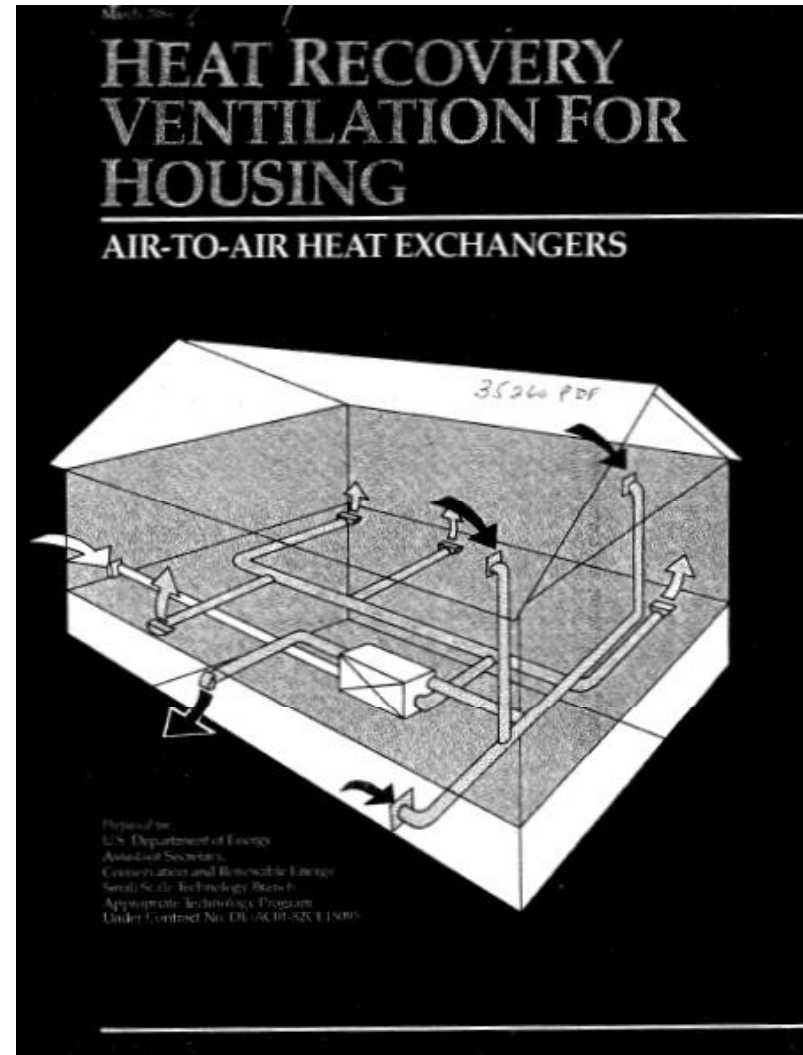

1984: DOE REPORT ON HRVS

- ✘ The report noted the adoption of superinsulated techniques: “While houses have generally been built tighter during the last decade, one of the major features of superinsulation is virtually airtight construction. ... These techniques, combined with much more insulation than conventional houses use (often R-60 ceilings, R-40 walls, and R-20 or R-20 under floors and around foundations in cold climates) make for space heating costs that have been shown to be as low as \$100 annually or less in our coldest climates.”

1984: DOE REPORT ON HRVS

The evolution of insulation levels for residential buildings in cold climates.

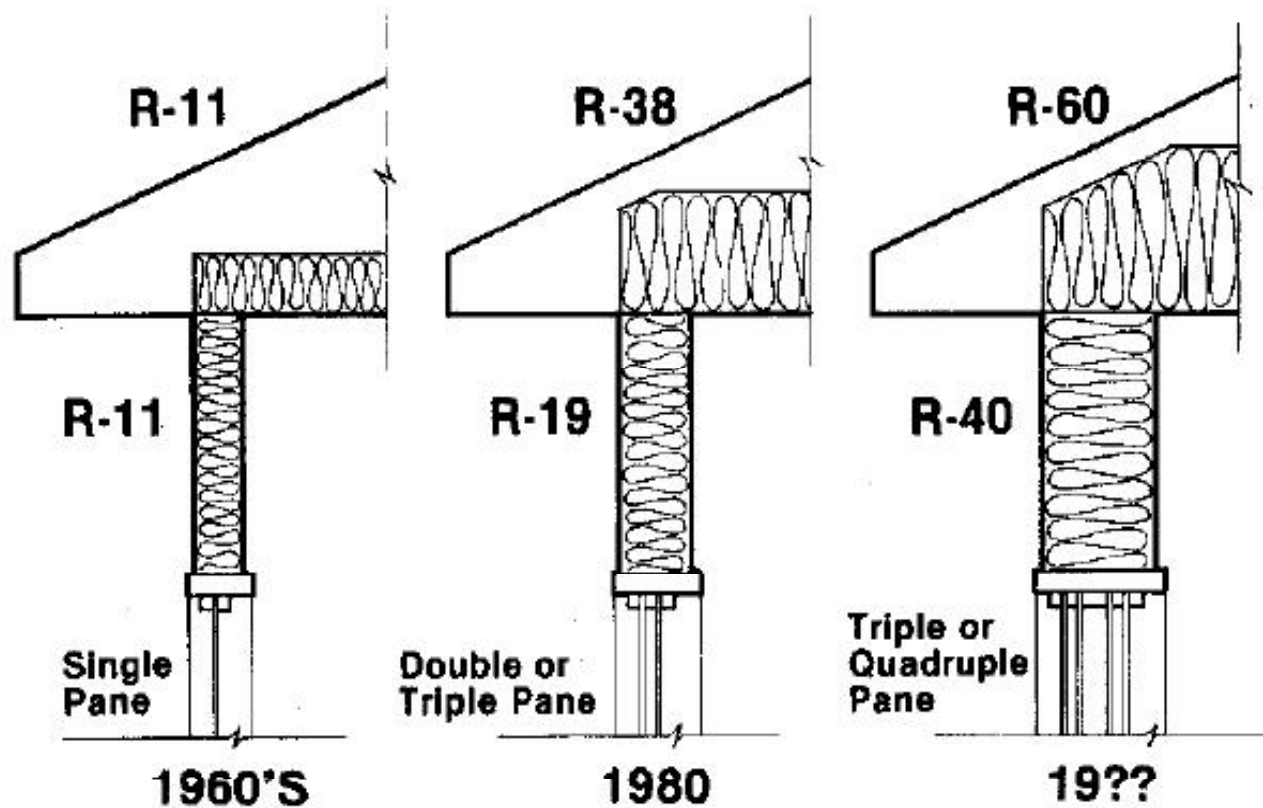

1984: DOE REPORT ON HRVS

- ✘ “More than 20 firms currently produce residential air-to-air heat exchangers for the market in the United States.”

1984: RETROFIT SUPERINSULATION ARTICLE

“Retrofit Superinsulation,” an article by John Hughes, appeared in the April 1984 issue of *Fine Homebuilding*.

The article showed how 12-inch-deep Larsen trusses can be used to add R-42 insulation to the exterior of an existing house.

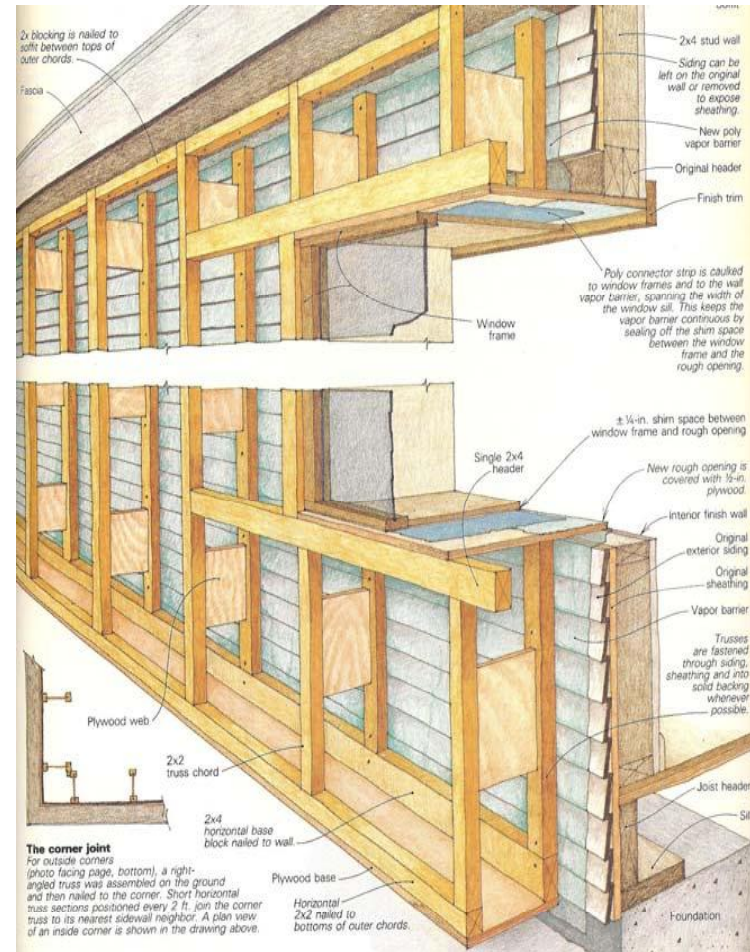

1985: THE SUPERINSULATED HOME BOOK

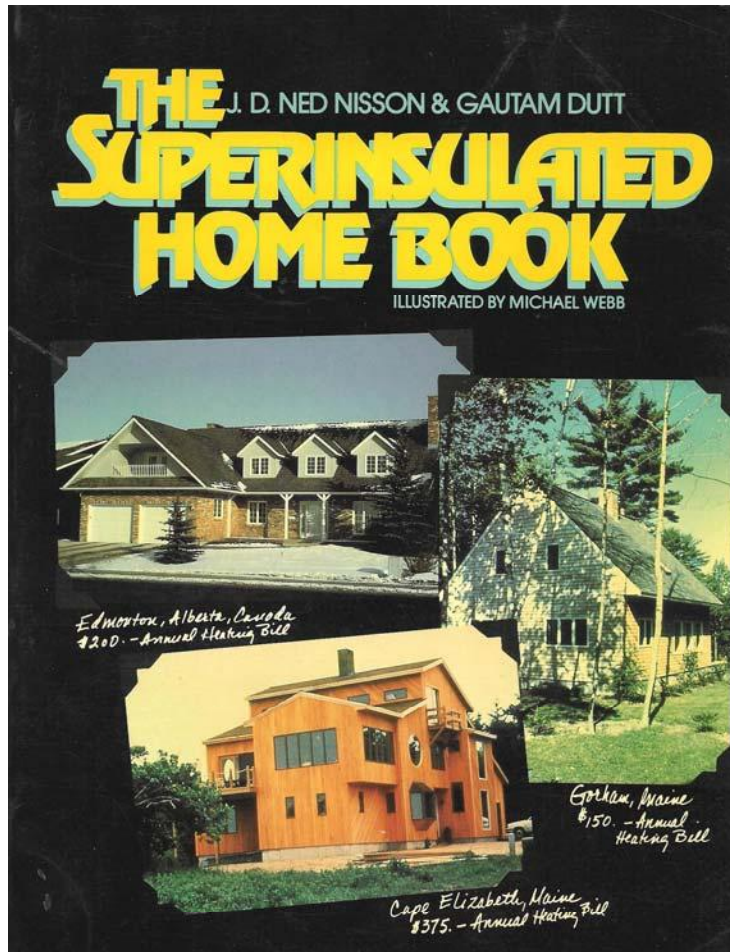

The authors were:

- J. Ned Nisson, editor of *Energy Design Update*, and
- Gautam Dutt, an engineer at Princeton University's Center for Energy and Environmental Studies.

1985: THE SUPERINSULATED HOME BOOK

Nisson and Dutt emphasized air sealing. The book provided details for:

- ✘ Double-stud walls
- ✘ Larsen-truss walls
- ✘ Foam sheathed walls
- ✘ Low-e coatings and argon-gas-filled glazing
- ✘ Triple-glazed windows

EVERYTHING IS IN PLACE

- ✘ So, in 1985, everything is in place:
- ✘ The research has been done;
- ✘ There are books and magazines that provide superinsulation details;
- ✘ Builders can buy low-e windows, HRVs, and blower doors.
- ✘ So what happened?

DROPPING THE BALL

- ✘ The price of oil dropped from \$32 per barrel in 1982 to \$11 in 1986.
- ✘ In the U.S., President Reagan slashed funding for a variety of energy-efficiency programs established by Jimmy Carter.

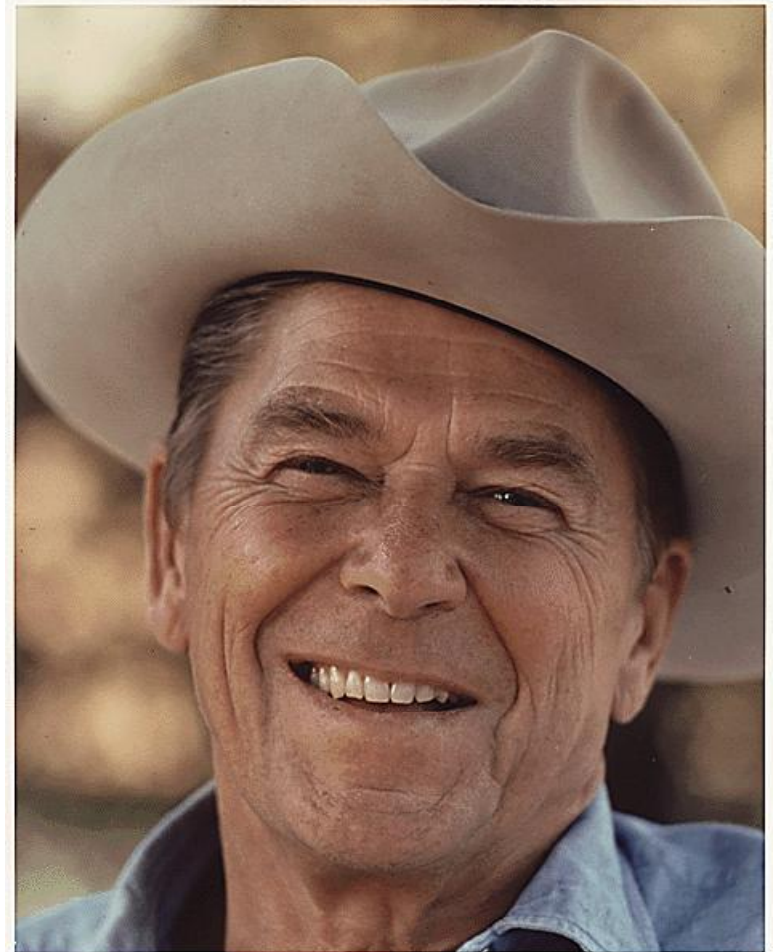

MEANWHILE, IN SWEDEN

- ✘ In 1977, Sweden implemented a new building code that effectively mandated triple-glazed windows.
- ✘ Sweden also required new homes to pass a blower-door test before an occupancy permit could be issued.

1996: FEIST FOUNDS PASSIVHAUS INSTITUT



Dr. Wolfgang Feist:
“The building process for the first Passivhaus prototype started in 1990. At the time we knew about other similar buildings — buildings made by William Schurcliff and Harold Orr — and we relied on these ideas.”

WHAT'S NEW SINCE 1985?

- ✘ Better energy modeling software (PHPP)
- ✘ Better moisture-management details
- ✘ Better windows — with better glazing options, better warm-edge spacers, and better frames
- ✘ More efficient and dependable HRVs

WHY HISTORY MATTERS

- ✘ An example of why we need to understand this history: Many advocates of deep-energy retrofits claim that more demonstration projects and research is necessary. They hope that such research will lead to orders-of-magnitude cost reductions.
- ✘ They probably don't realize that these retrofits were being done in the 1980s. The cost of the work is simply the cost of ordinary construction and weatherization work – which is why the costs are unlikely to come down.

TODAY'S ARCHITECTS AND BUILDERS

- ✘ The young architects of the 21st century — recently graduated from architecture school — are all fired up to build energy-efficient houses.
- ✘ How many of them are aware of the history of the superinsulation movement of the 1980s — its failures as well as its successes?

THE ROAD NOT TAKEN

- ✘ Imagine if, in the 1970s, the U.S. and Canada had implemented building code changes like those passed in Sweden.
- ✘ When American energy experts made suggestions along those lines, they were ignored.
- ✘ In some cases, they were actively opposed by lobbyists hired by the National Association of Home Builders.

THANKS

Martin Holladay

martin@greenbuildingadvisor.com